

**RoHS Lxx04xx & Qxx04xx Series**

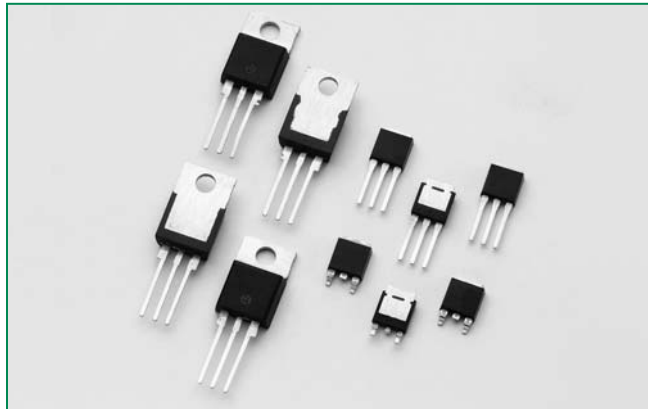

**Description**

4 Amp bi-directional solid state switch series is designed for AC switching and phase control applications such as motor speed and temperature modulation controls, lighting controls, and static switching relays.

**Sensitive** type devices guarantee gate control in Quadrants I & IV needed for digital control circuitry.

**Standard** type devices normally operate in Quadrants I & III triggered from AC line.

**Features & Benefits**

- RoHS Compliant
- Glass – passivated junctions
- Voltage capability up to 1000 V
- Surge capability up to 55 A
- Electrically isolated “L-Package” is UL recognized for 2500Vrms
- Solid-state switching eliminates arcing or contact bounce that create voltage transients
- No contacts to wear out from reaction of switching events
- Restricted (or limited) RFI generation, depending on activation point of sine wave
- Requires only a small gate activation pulse in each half-cycle

**Agency Approval**

Agency	Agency File Number
	L Package : E71639

**Main Features**

Symbol	Value	Unit
$I_{T(RMS)}$	4	A
$V_{DRM} / V_{RRM}$	400 to 1000	V
$I_{GT (Q1)}$	3 to 25	mA

**Schematic Symbol**

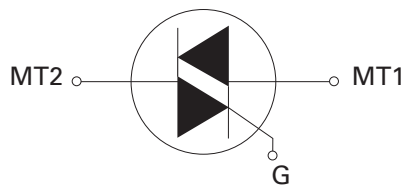

**Applications**

Typical applications are AC solid-state switches, power tools, home/brown goods and white goods appliances.

Sensitive gate Triacs can be directly driven by microprocessor or popular opto-couplers/isolators.

Internally constructed isolated packages are offered for ease of heat sinking with highest isolation voltage.

**Absolute Maximum Ratings – Sensitive Triacs (4 Quadrants)**

Symbol	Parameter	Value	Unit	
$I_{T(RMS)}$	RMS on-state current (full sine wave)	Lxx04Ly / Lxx04Dy $T_c = 85^\circ C$	4	A
		Lxx04Ry / Lxx04Vy $T_c = 75^\circ C$		
$I_{TSM}$	Non repetitive surge peak on-state current (full cycle, $T_j$ initial = $25^\circ C$ )	f = 50 Hz t = 20 ms	33	A
		f = 60 Hz t = 16.7 ms		
$I^2t$	$I^2t$ Value for fusing	$t_p = 8.3$ ms	6.6	A <sup>2</sup> s
di/dt	Critical rate of rise of on-state current ( $I_g = 50$ mA with $\leq 0.1$ µs rise time)	f = 120 Hz $T_j = 110^\circ C$	50	A/µs
$I_{GTM}$	Peak gate trigger current	$t_p \leq 10$ µs $T_j = 110^\circ C$	1.2	A
$P_{G(AV)}$	Average gate power dissipation	$T_j = 110^\circ C$	0.3	W
$T_{stg}$	Storage temperature range		-40 to 150	°C
$T_j$	Operating junction temperature range		-40 to 110	°C

Note: xx = voltage, y = sensitivity

**Absolute Maximum Ratings — Standard Triacs**

Symbol	Parameter			Value	Unit
$I_{T(RMS)}$	RMS on-state current (full sine wave)	Qxx04Ly / Qxx04Dy	$T_C = 95^\circ\text{C}$	4	A
		Qxx04Ry / Qxx04Vy	$T_C = 85^\circ\text{C}$		
$I_{TSM}$	Non repetitive surge peak on-state current (full cycle, $T_J$ initial = $25^\circ\text{C}$ )	f = 50 Hz	t = 20 ms	46	A
		f = 60 Hz	t = 16.7 ms	55	
$I^2t$	$I^2t$ Value for fusing	$t_p = 8.3$ ms		12.5	$\text{A}^2\text{s}$
di/dt	Critical rate of rise of on-state current ( $I_G = 50\text{mA}$ with $\leq 0.1\mu\text{s}$ rise time)	f = 120 Hz	$T_J = 125^\circ\text{C}$	50	$\text{A}/\mu\text{s}$
$I_{GTM}$	Peak gate trigger current	$t_p \leq 10 \mu\text{s};$ $I_{GT} \leq I_{GTM}$	$T_J = 125^\circ\text{C}$	1.2	A
$P_{G(AV)}$	Average gate power dissipation		$T_J = 125^\circ\text{C}$	0.3	W
$T_{stg}$	Storage temperature range			-40 to 150	$^\circ\text{C}$
$T_J$	Operating junction temperature range			-40 to 125	$^\circ\text{C}$

Note: xx = voltage, y = sensitivity

**Electrical Characteristics ( $T_J = 25^\circ\text{C}$ , unless otherwise specified) — Sensitive Triac (4 Quadrants)**

Symbol	Test Conditions	Quadrant	Lxx04x3	Lxx04x5	Lxx04x6	Lxx04x8	Unit
$I_{GT}$	$V_D = 12\text{V}$ $R_L = 60 \Omega$	I – II – III	3	5	5	10	mA
		IV	3	5	10	20	
$V_{GT}$		ALL	1.3				V
$V_{GD}$	$V_D = V_{DRM}$ $R_L = 3.3 \text{k}\Omega$ $T_J = 110^\circ\text{C}$	ALL	0.2				V
$I_H$	$I_T = 100\text{mA}$	MAX.	5	10	10	15	mA
dv/dt	$V_D = V_{DRM}$ Gate Open $T_J = 100^\circ\text{C}$	400V	25	25	30	35	$\text{V}/\mu\text{s}$
		600V	15	15	20	25	
(dv/dt)c	(di/dt)c = 2.16 A/ms $T_J = 110^\circ\text{C}$	TYP.	0.5	1	1	1	$\text{V}/\mu\text{s}$
$t_{gt}$	$I_G = 2 \times I_{GT}$ $\text{PW} = 15\mu\text{s}$ $I_T = 5.6 \text{A(pk)}$	TYP.	2.8	3.0	3.0	3.2	$\mu\text{s}$

**Electrical Characteristics ( $T_J = 25^\circ\text{C}$ , unless otherwise specified) — Standard Triac**

Symbol	Test Conditions	Quadrant	Qxx04x3	Qxx04x4	Unit
$I_{GT}$	$V_D = 12\text{V}$ $R_L = 60 \Omega$	I – II – III	10	25	mA
		IV	25	50	
$V_{GT}$		I – II – III	1.3	1.3	V
$V_{GD}$	$V_D = V_{DRM}$ $R_L = 3.3 \text{k}\Omega$ $T_J = 125^\circ\text{C}$	ALL	0.2	0.2	V
$I_H$	$I_T = 200\text{mA}$	MAX.	20	30	mA
dv/dt	$V_D = V_{DRM}$ Gate Open $T_J = 125^\circ\text{C}$	400V	40	75	$\text{V}/\mu\text{s}$
		600V	30	50	
		800V		40	
	$V_D = V_{DRM}$ Gate Open $T_J = 100^\circ\text{C}$	1000V		50	
(dv/dt)c	(di/dt)c = 2.16 A/ms $T_J = 125^\circ\text{C}$	TYP.	2	2	$\text{V}/\mu\text{s}$
$t_{gt}$	$I_G = 2 \times I_{GT}$ $\text{PW} = 15\mu\text{s}$ $I_T = 5.6 \text{A(pk)}$	TYP.	2.5	3.0	$\mu\text{s}$

Note: xx = voltage, x = package

**Static Characteristics ( $T_J = 25^\circ\text{C}$ , unless otherwise specified)**

Symbol	Test Conditions		Value	Unit		
$V_{TM}$	$I_{TM} = 5.6\text{A}$ $t_p = 380 \mu\text{s}$	MAX.	1.60	V		
$I_{DRM}$ $I_{RRM}$	$V_{DRM} = V_{RRM}$	MAX.	Lxx04xy	$T_J = 25^\circ\text{C}$ 400-600V	5	$\mu\text{A}$
				$T_J = 110^\circ\text{C}$ 400-600V	200	$\mu\text{A}$
			Qxx04xy	$T_J = 25^\circ\text{C}$ 400-1000V	10	$\mu\text{A}$
				$T_J = 125^\circ\text{C}$ 400-800V	2	mA
				$T_J = 100^\circ\text{C}$ 1000V	3	

**Thermal Resistances**

Symbol	Parameter	Value	Unit
$R_{\theta(J-C)}$	Junction to case (AC)	L/Qxx04Dy	3.5
		L/Qxx04Ly	3.6
		L/Qxx04Ry / L/Qxx04Vy	6.0
$R_{\theta(J-A)}$	Junction to ambient	L/Qxx04Ly	50
		L/Qxx04Ry / L/Qxx04Vy	70

Note: xx = voltage, x = package, y = sensitivity

**Figure 1: Definition of Quadrants**

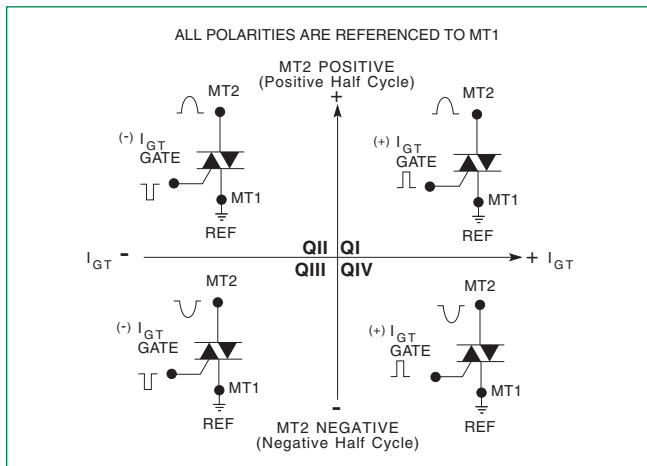

**Figure 2: Normalized DC Gate Trigger Current for All Quadrants vs. Junction Temperature**

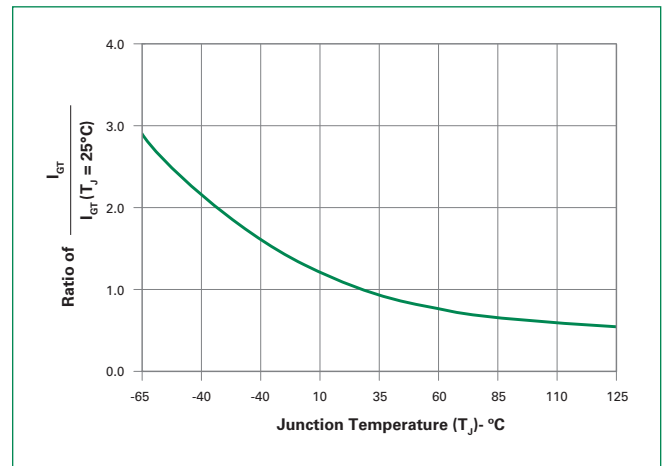

Figure 3: Normalized DC Holding Current vs. Junction Temperature

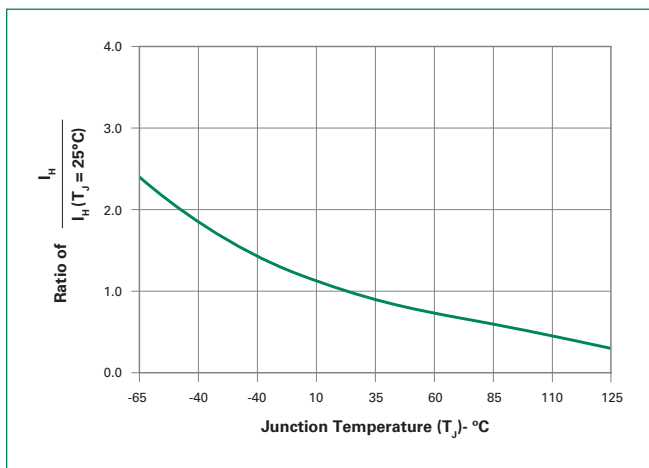

Figure 4: Normalized DC Gate Trigger Voltage for All Quadrants vs. Junction Temperature

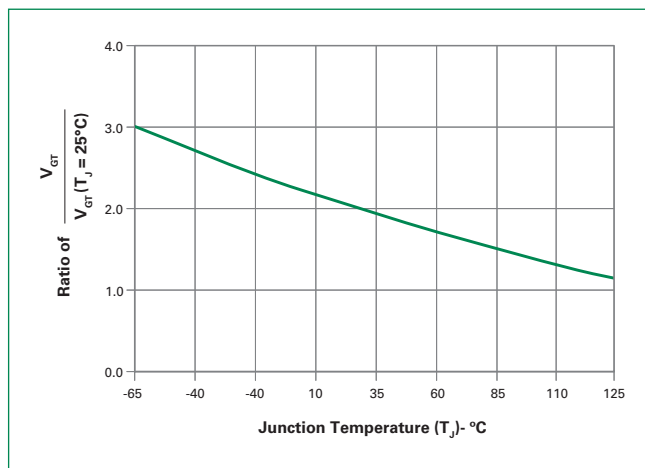

Figure 5: Power Dissipation (Typical) vs. RMS On-State Current

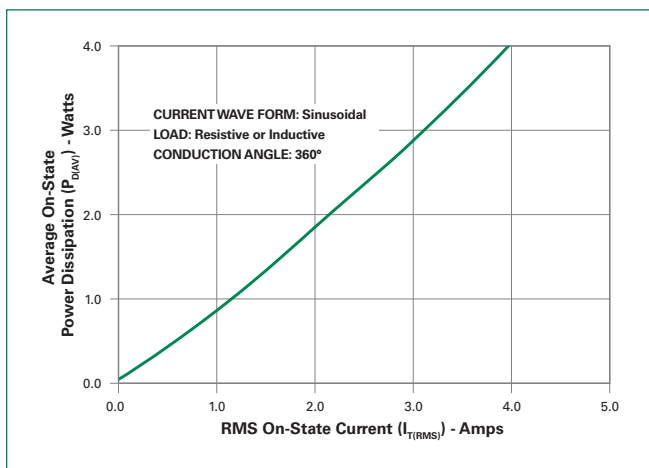

Figure 6: Maximum Allowable Case Temperature vs. On-State Current

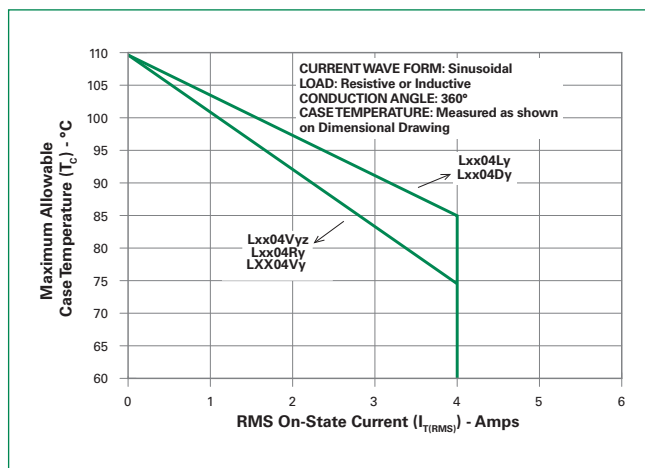

Figure 7: Maximum Allowable Case Temperature vs. On-State Current

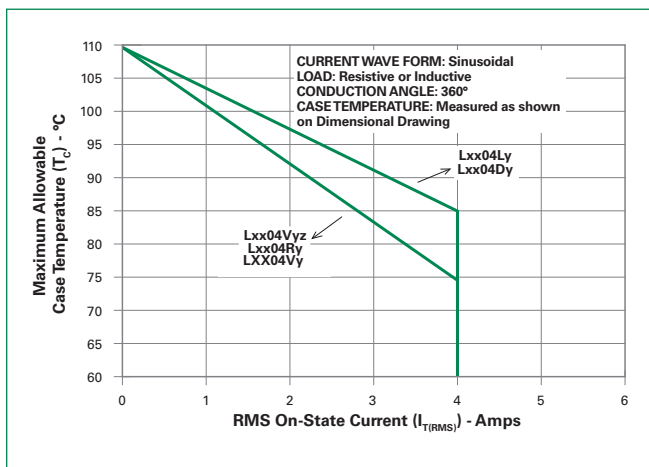
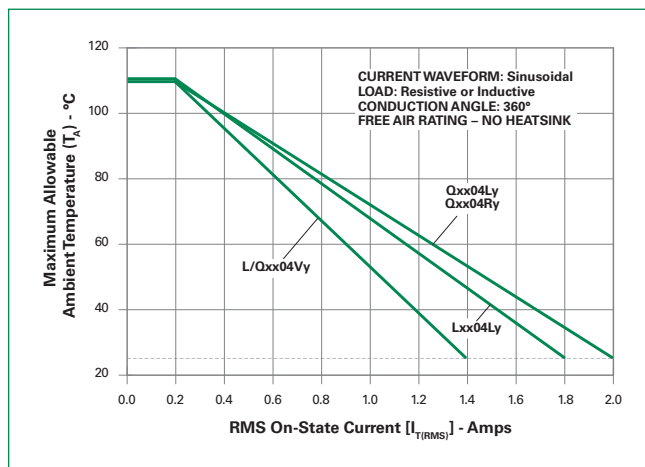
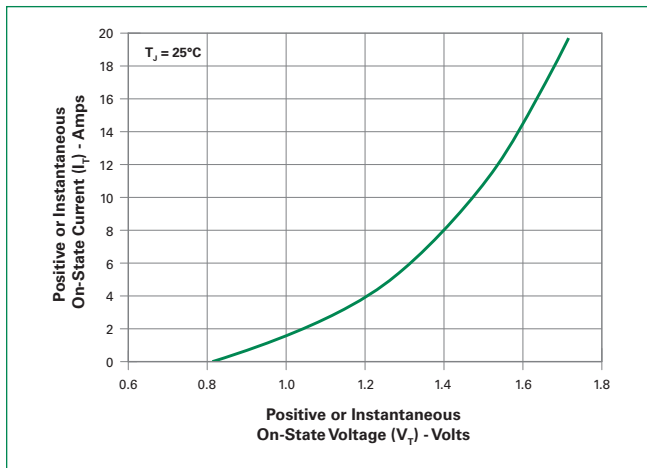

Figure 8: Maximum Allowable Ambient Temperature vs. On-State Current



Note: xx = voltage, y = sensitivity

**Figure 9: On-State Current vs. On-State Voltage (Typical)**



**Figure 10: Surge Peak On-State Current vs. Number of Cycles**

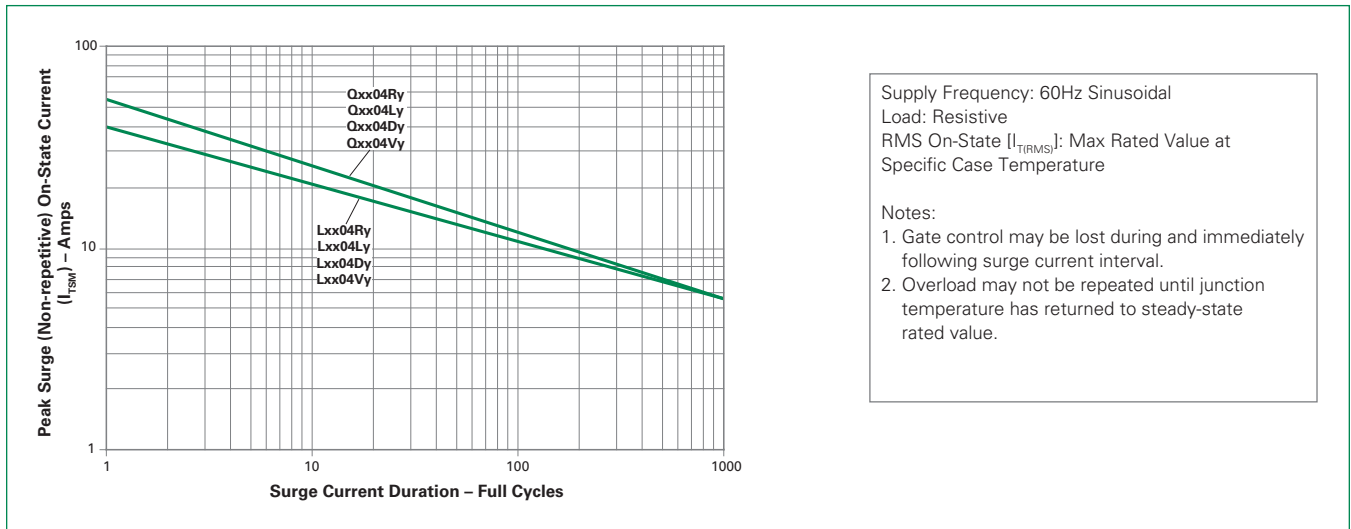

Note: xx = voltage, y = sensitivity

### Soldering Parameters

Reflow Condition		Pb – Free assembly
Pre Heat	- Temperature Min ( $T_{s(min)}$ )	150°C
	- Temperature Max ( $T_{s(max)}$ )	200°C
	- Time (min to max) ( $t_s$ )	60 – 190 secs
Average ramp up rate (Liquidus Temp) ( $T_L$ ) to peak		5°C/second max
$T_{s(max)}$ to $T_L$ - Ramp-up Rate		5°C/second max
Reflow	- Temperature ( $T_L$ ) (Liquidus)	217°C
	- Temperature ( $t_L$ )	60 – 150 seconds
Peak Temperature ( $T_p$ )		260°C $\pm 0/5$
Time within 5°C of actual peak Temperature ( $t_p$ )		20 – 40 seconds
Ramp-down Rate		5°C/second max
Time 25°C to peak Temperature ( $T_p$ )		8 minutes Max.
Do not exceed		280°C

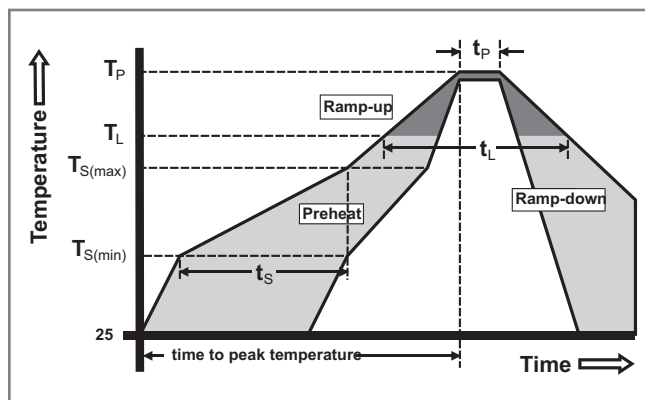

### Physical Specifications

<b>Terminal Finish</b>	100% Matte Tin-plated
<b>Body Material</b>	UL recognized epoxy meeting flammability classification 94V-0
<b>Terminal Material</b>	Copper Alloy

### Design Considerations

Careful selection of the correct device for the application's operating parameters and environment will go a long way toward extending the operating life of the Thyristor. Good design practice should limit the maximum continuous current through the main terminals to 75% of the device rating. Other ways to ensure long life for a power discrete semiconductor are proper heat sinking and selection of voltage ratings for worst case conditions. Overheating, overvoltage (including dv/dt), and surge currents are the main killers of semiconductors. Correct mounting, soldering, and forming of the leads also help protect against component damage.

### Environmental Specifications

Test	Specifications and Conditions
<b>AC Blocking</b>	MIL-STD-750, M-1040, Cond A Applied Peak AC voltage @ 125°C for 1008 hours
<b>Temperature Cycling</b>	MIL-STD-750, M-1051, 100 cycles; -40°C to +150°C; 15-min dwell time
<b>Temperature/Humidity</b>	EIA / JEDEC, JESD22-A101 1008 hours; 320V - DC: 85°C; 85% rel humidity
<b>High Temp Storage</b>	MIL-STD-750, M-1031, 1008 hours; 150°C
<b>Low-Temp Storage</b>	1008 hours; -40°C
<b>Thermal Shock</b>	MIL-STD-750, M-1056 10 cycles; 0°C to 100°C; 5-min dwell time at each temperature; 10 sec (max) transfer time between temperature
<b>Autoclave</b>	EIA / JEDEC, JESD22-A102 168 hours (121°C at 2 ATMs) and 100% R/H
<b>Resistance to Solder Heat</b>	MIL-STD-750 Method 2031
<b>Solderability</b>	ANSI/J-STD-002, category 3, Test A
<b>Lead Bend</b>	MIL-STD-750, M-2036 Cond E

**Dimensions — TO-220AB (R-Package) — Non-Isolated Mounting Tab Common with Center Lead**

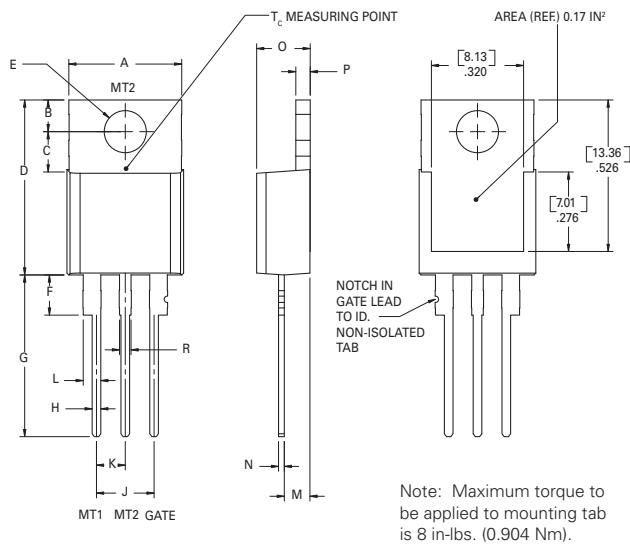

Dimension	Inches		Millimeters	
	Min	Max	Min	Max
A	0.380	0.420	9.65	10.67
B	0.105	0.115	2.67	2.92
C	0.230	0.250	5.84	6.35
D	0.590	0.620	14.99	15.75
E	0.142	0.147	3.61	3.73
F	0.110	0.130	2.79	3.30
G	0.540	0.575	13.72	14.61
H	0.025	0.035	0.64	0.89
J	0.195	0.205	4.95	5.21
K	0.095	0.105	2.41	2.67
L	0.060	0.075	1.52	1.91
M	0.085	0.095	2.16	2.41
N	0.018	0.024	0.46	0.61
O	0.178	0.188	4.52	4.78
P	0.045	0.060	1.14	1.52
R	0.038	0.048	0.97	1.22

4.0A TRIACS

**Dimensions — TO-220AB (L-Package) — Isolated Mounting Tab**

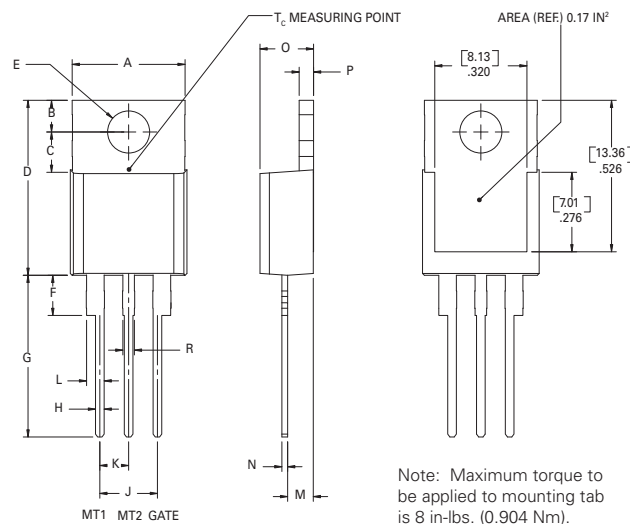

Dimension	Inches		Millimeters	
	Min	Max	Min	Max
A	0.380	0.420	9.65	10.67
B	0.105	0.115	2.67	2.92
C	0.230	0.250	5.84	6.35
D	0.590	0.620	14.99	15.75
E	0.142	0.147	3.61	3.73
F	0.110	0.130	2.79	3.30
G	0.540	0.575	13.72	14.61
H	0.025	0.035	0.64	0.89
J	0.195	0.205	4.95	5.21
K	0.095	0.105	2.41	2.67
L	0.060	0.075	1.52	1.91
M	0.085	0.095	2.16	2.41
N	0.018	0.024	0.46	0.61
O	0.178	0.188	4.52	4.78
P	0.045	0.060	1.14	1.52
R	0.038	0.048	0.97	1.22

**Dimensions — TO-251AA (V-Package) — V-PAK Through Hole**

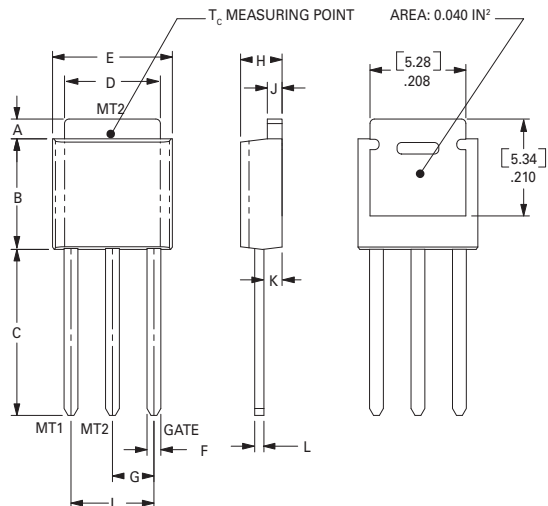

Dimension	Inches		Millimeters	
	Min	Max	Min	Max
A	0.040	0.050	1.02	1.27
B	0.235	0.245	5.97	6.22
C	0.350	0.375	8.89	9.53
D	0.205	0.213	5.21	5.41
E	0.255	0.265	6.48	6.73
F	0.027	0.033	0.69	0.84
G	0.087	0.093	2.21	2.36
H	0.085	0.095	2.16	2.41
I	0.176	0.184	4.47	4.67
J	0.018	0.023	0.46	0.58
K	0.038	0.044	0.97	1.12
L	0.018	0.023	0.46	0.58

**Dimensions — TO-252AA (D-Package) — D-PAK Surface Mount**

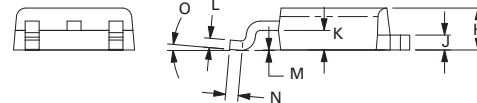
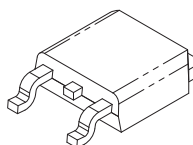
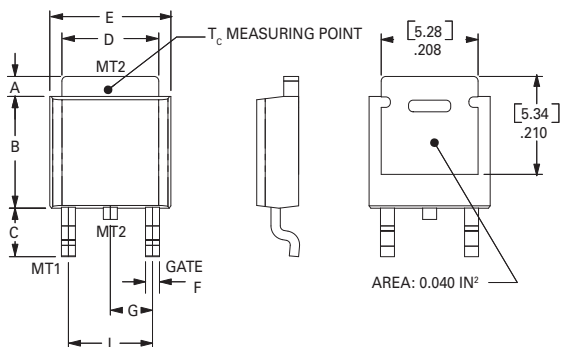

Pad Layout for TO-252AA (D-Package)

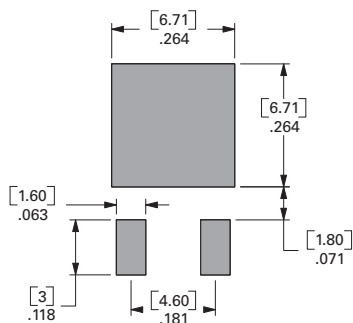

Dimension	Inches		Millimeters	
	Min	Max	Min	Max
A	0.040	0.050	1.02	1.27
B	0.235	0.245	5.97	6.22
C	0.106	0.113	2.69	2.87
D	0.205	0.213	5.21	5.41
E	0.255	0.265	6.48	6.73
F	0.027	0.033	0.69	0.84
G	0.087	0.093	2.21	2.36
H	0.085	0.095	2.16	2.41
I	0.176	0.184	4.47	4.67
J	0.018	0.023	0.46	0.58
K	0.038	0.044	0.97	1.12
L	0.018	0.023	0.46	0.58
M	0.000	0.004	0.00	0.10
N	0.021	0.027	0.53	0.69
O	0°	5°	0°	5°



**Product Selector**

Part Number	Voltage				Gate Sensitivity Quadrants		Type	Package
	400V	600V	800V	1000V	I – II – III	IV		
Lxx04L3	X	X			3 mA	3 mA	Sensitive Triac	TO-220L
Lxx04D3	X	X			3 mA	3 mA	Sensitive Triac	TO-252 D-PAK
Lxx04R3	X	X			3mA	3mA	Sensitive Triac	TO-220R
Lxx04V3	X	X			3 mA	3 mA	Sensitive Triac	TO-251 V-PAK
Lxx04L5	X	X			5 mA	5 mA	Sensitive Triac	TO-220L
Lxx04D5	X	X			5 mA	5 mA	Sensitive Triac	TO-252 D-PAK
Lxx04R5	X	X			5mA	5mA	Sensitive Triac	TO-220R
Lxx04V5	X	X			5 mA	5 mA	Sensitive Triac	TO-251 V-PAK
Lxx04L6	X	X			5 mA	10 mA	Sensitive Triac	TO-220L
Lxx04D6	X	X			5 mA	10 mA	Sensitive Triac	TO-252 D-PAK
Lxx04R6	X	X			5mA	10mA	Sensitive Triac	TO-220R
Lxx04V6	X	X			5 mA	10 mA	Sensitive Triac	TO-251 V-PAK
Lxx04L8	X	X			10 mA	20 mA	Sensitive Triac	TO-220L
Lxx04D8	X	X			10 mA	20 mA	Sensitive Triac	TO-252 D-PAK
Lxx04R8	X	X			10mA	20mA	Sensitive Triac	TO-220R
Lxx04V8	X	X			10 mA	20 mA	Sensitive Triac	TO-251 V-PAK
Qxx04L3	X	X			10 mA		Standard Triac	TO-220L
Qxx04D3	X	X			10 mA		Standard Triac	TO-252 D-PAK
Qxx04V3	X	X			10 mA		Standard Triac	TO-251 V-PAK
Qxx04R3	X	X			10mA		Standard Triac	TO-220R
Qxx04L4	X	X	X	X	25 mA		Standard Triac	TO-220L
Qxx04D4	X	X	X	X	25 mA		Standard Triac	TO-252 D-PAK
Qxx04R4	X	X	X	X	25mA		Standard Triac	TO-220R
Qxx04V4	X	X	X	X	25 mA		Standard Triac	TO-251 V-PAK

**Packing Options**

Part Number	Marking	Weight	Packing Mode	Base Quantity
L/Q004L/Ry/TP	L/Qxx04L/Ry	2.2 g	Bulk	500
L/Qxx04LyTP	L/Qxx04Ly	2.2 g	Tube	500
L/Qxx04DyRP	L/Qxx04Dy	0.3 g	Embossed Carrier	2500
L/Qxx04DyTP	L/Qxx04Dy	0.3 g	Tube Pack	750
L/Qxx04VyTP	L/Qxx04Vy	0.4 g	Tube Pack	750

Note: xx = Voltage; y = Sensitivity

### TO-252 Embossed Carrier Reel Pack (RP) Specifications

Meets all EIA-481-2 Standards

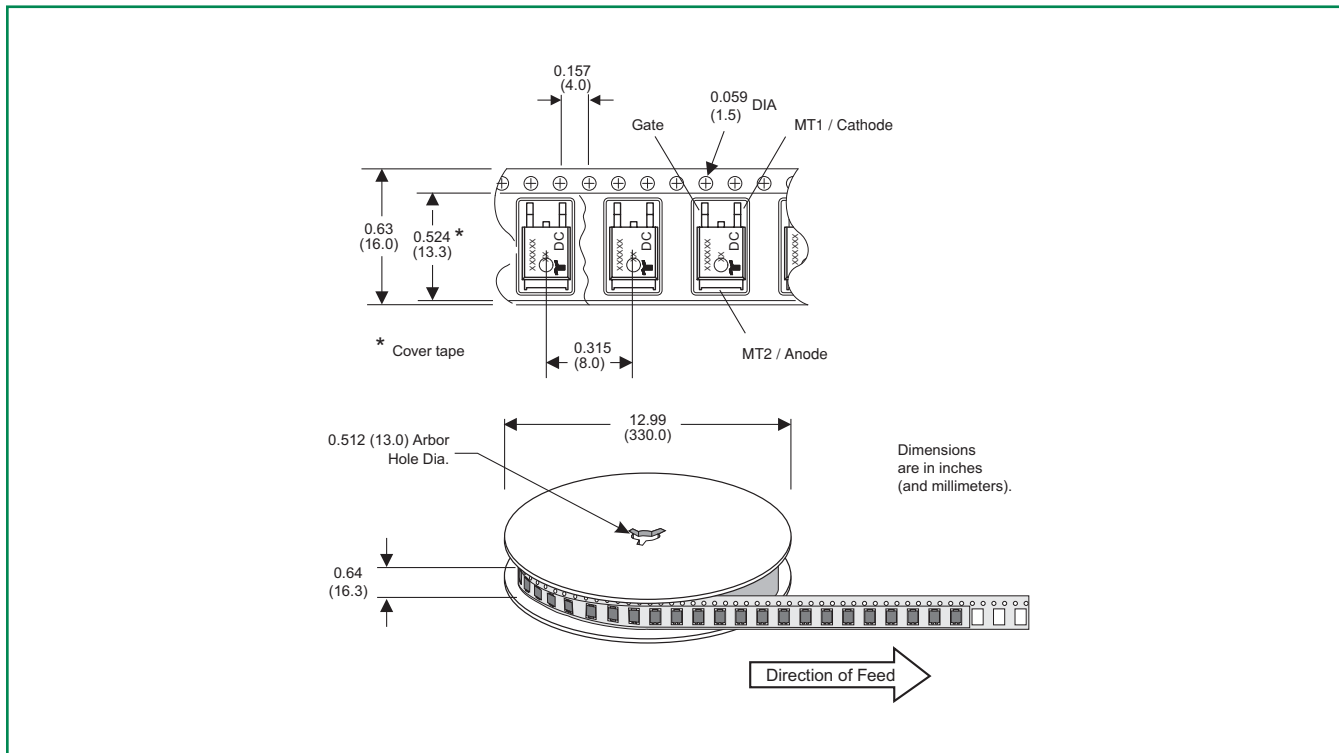

### Part Numbering System

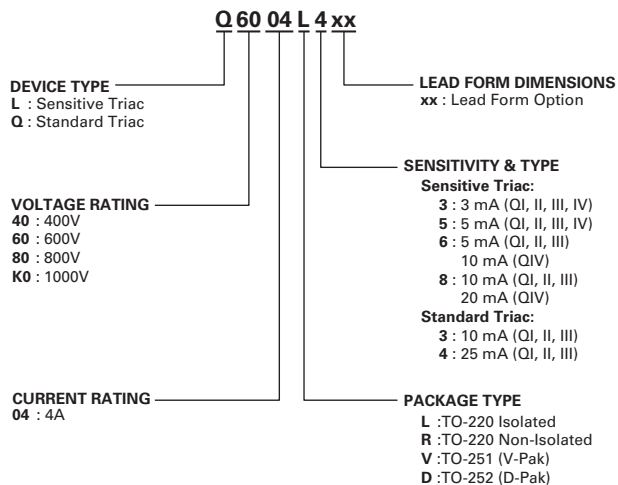

### Part Marking System

TO-220 AB  
(R & L Packages)

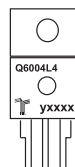

TO-251AA &  
TO-252AA  
(V and D Packages)

